

**Coves**

Coves are commonly used to soften the transition on inside corners but may be used for a wide range of applications.

**ALL SIZES NOMINAL**



M&M#	Cove
84L	9/16" x 2-1/4" - RL Solid Pine
85	9/16" x 1-3/4" - RL + 8' Solid Pine
86	9/16" x 1-5/8" - RL Solid Pine

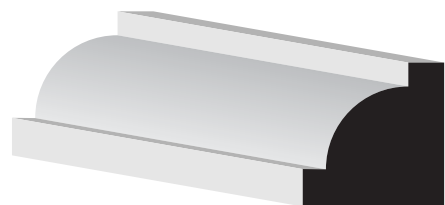

M&M#	Reverse Cove
5012POP	3/4" x 3/4" - RL Poplar



M&M#	Cove
2024POP	5/8" x 3/4" - RL Poplar



M&M#	Reverse Cove
100O	11/16" x 11/16" - RL Oak
100P	11/16" x 11/16" - 16' FJ Pine Primed
100	11/16" x 11/16" - RL + 8' Solid Pine



M&M#	Cove
96LPOP	1/2" x 3/4" - RL Poplar

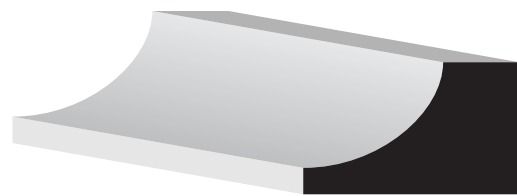

M&M#	Cove
90	11/16" x 1-1/8" - RL Solid Pine



M&M#	Cove
101	1/2" x 1/2" - RL Solid Pine
101O	1/2" x 1/2" - RL Oak
93	3/4" x 3/4" - RL + 8' Solid Pine
93O	3/4" x 3/4" - RL Oak
93POP	3/4" x 3/4" - RL Poplar
93PRI	3/4" x 3/4" - 16' FJ Pop Primed
93MAP	3/4" x 3/4" - 16' Maple

**Chair Rails**

Chair Rails are practical as well as decorative. Applied to a wall, anywhere from 24 to 48 inches from the floor, they protect the wall from scuffs and dents from the backs of chairs as well as adding a distinctive accent to any room.

**ALL SIZES NOMINAL**

M&M#	Chair Rail
16104CHPOP	1/2" x 3-1/4" - RL Poplar

M&M#	Chair Rail
203CHPOP	11/16" x 2-3/8" - RL Poplar



M&M#	Chair Rail
2288CHPOP	11/16" x 2-3/4" - RL Poplar

M&M#	Chair Rail
22104CHPOP	11/16" x 3-1/4" - RL Poplar

M&M#	Chair Rail
32104CHPOP	1" x 3-1/4" - RL Poplar
32104CHP	1" x 3-1/4" - 16' FJ Pine Primed
32104CHM	1" x 3-1/4" - 16' Ultralite
32104CHO	1" x 3-1/4" - RL Oak
32104CHPRI	1" x 3-1/4" - 16' FJ Pop Primed

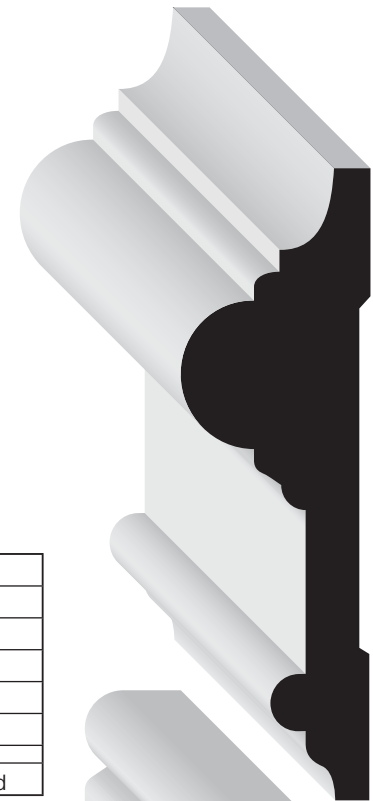
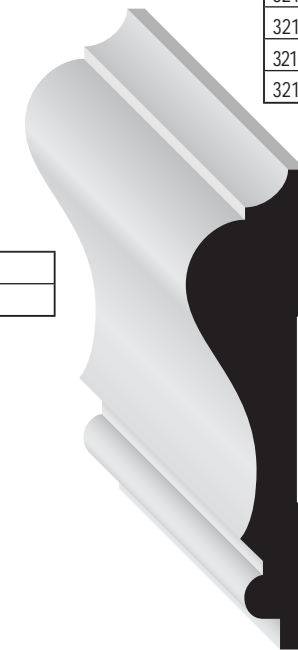

M&M#	Chair Rail
390LPOP	5/8" x 2-1/2" - RL Poplar
390J	11/16" x 2-5/8" - 16' FJ Pine Jesso
390	11/16" x 2-5/8" - RL Solid Pine
390MO	5/8" x 2-1/2" - RL Oak
390LM	5/8" x 2-1/2" - 16' Ultralite
9320PRI	5/8" x 2-5/8" - 16' FJ Pop Primed



M&M#	Chair Rail
5006POP	13/16" x 2-1/2" - RL Poplar

M&M#	Chair Rail Backer
200CHPOP	11/16" x 4-1/4" - RL Poplar